

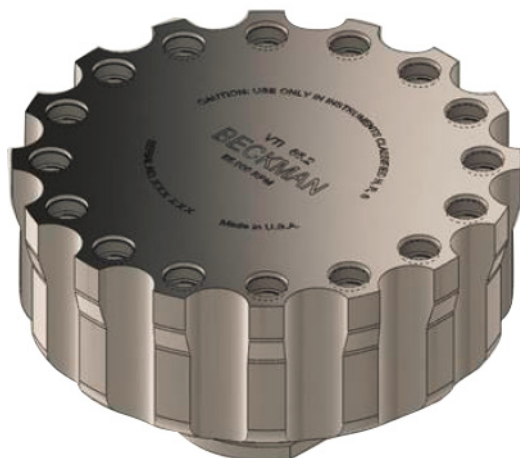

Instructions For Use

VTi 65.2 Vertical-Tube Rotor

For Use in Beckman Coulter
Class H, R, and S
Preparative Ultracentrifuges



PN L5-TB-089HD
February 2019



Beckman Coulter, Inc.
250 S. Kraemer Blvd.
Brea, CA 92821 U.S.A.



VTi 65.2 Vertical-Tube Rotor
PN L5-TB-089HD (February 2019)

© 2019 Beckman Coulter, Inc.
All rights reserved

Beckman Coulter, the stylized logo, and the Beckman Coulter product and service marks mentioned herein are trademarks or registered trademarks of Beckman Coulter, Inc. in the United States and other countries.

All other trademarks, service marks, products, or services are trademarks or registered trademarks of their respective holders.

Contact Us

If you have any questions, contact our Customer Support Center.

- Worldwide, find us via our website at www.beckman.com/support/technical.
- In the USA and Canada, call us at 1-800-369-0333.
- Outside of the USA and Canada, contact your local Beckman Coulter Representative.

Find us on the World Wide Web at: www.beckman.com



Beckman Coulter Eurocenter S.A.
22, rue Juste-Olivier
Case Postale 1044
CH - 1260 Nyon 1, Switzerland
Tel: +41 (0) 22 365 36 11

Glossary of Symbols is available at beckman.com/techdocs (PN C24689).

Revision History

This document applies to the latest version listed and higher versions. When a subsequent version changes the information in this document, a new issue will be released to the Beckman Coulter website. For updates, go to www.beckman.com/techdocs and download the latest version of the manual for your rotor.

Issue HD, 02/19

Updates were made to the following: *Product Graphic, Specifications*

Safety Notice

Read all product manuals and consult with Beckman Coulter-trained personnel before attempting to use this equipment. Do not attempt to perform any procedure before carefully reading all instructions. Always follow product labeling and manufacturer's recommendations. If in doubt as to how to proceed in any situation, contact your Beckman Coulter Representative.



This safety notice summarizes information basic to the safe use of the rotor described in this manual. The international symbol displayed to the left is a reminder to the user that all safety instructions should be read and understood before operation or maintenance of this equipment is attempted. When you see the symbol on other pages of this publication, pay special attention to the safety information presented. Observance of safety precautions will also help to avoid actions that could damage or adversely affect the performance of the rotor. This rotor was developed, manufactured, and tested for safety and reliability as part of a Beckman Coulter ultracentrifuge/rotor system. Its safety or reliability cannot be assured if used in a centrifuge not of Beckman Coulter's manufacture or in a Beckman Coulter ultracentrifuge that has been modified without Beckman Coulter's approval.

Alerts for Warning, Caution, and Note

WARNING

WARNING indicates a potentially hazardous situation which, if not avoided, could result in death or serious injury.

CAUTION

CAUTION indicates a potentially hazardous situation, which, if not avoided, may result in minor or moderate injury. It may also be used to alert against unsafe practices.

NOTE NOTE is used to call attention to notable information that should be followed during installation, use, or servicing of this equipment.

Safety Information for the VTi 65.2 Rotor

Handle body fluids with care because they can transmit disease. No known test offers complete assurance that such fluids are free of micro-organisms. Some of the most virulent – Hepatitis (B and C) viruses, HIV (I–V), atypical mycobacteria, and certain systemic fungi – further emphasize the need for aerosol protection. Handle other infectious samples according to good laboratory procedures and methods to prevent spread of disease. Because spills may generate aerosols, observe proper safety precautions for aerosol containment. Do not run toxic, pathogenic, or radioactive materials in this rotor without taking appropriate safety precautions. Biosafe containment should be used when Risk Group II materials (as identified in the World Health

Safety Notice

Safety Information for the VTi 65.2 Rotor

Organization *Laboratory Biosafety Manual*) are handled; materials of a higher group require more than one level of protection.

The rotor and accessories are not designed for use with materials capable of developing flammable or explosive vapors. Do not centrifuge such materials in nor handle or store them near the ultracentrifuge.

Although rotor components and accessories made by other manufacturers may fit in the VTi 65.2 rotor, their safety in this rotor cannot be ascertained by Beckman Coulter. Use of other manufacturers' components or accessories in the VTi 65.2 rotor may void the rotor warranty and should be prohibited by your laboratory safety officer. Only the components and accessories listed in this publication should be used in this rotor.

Do not run an empty rotor. Place filled tubes in at least two opposing cavities. Make sure that filled containers are loaded symmetrically into the rotor and that opposing tubes are filled to the same level with liquid of the same density. Make sure that cavities in use have the proper spacers inserted before installing the rotor plugs.

If disassembly reveals evidence of leakage, you should assume that some fluid escaped the rotor. Apply appropriate decontamination procedures to the centrifuge and accessories if pathogenic or radioactive materials are involved.

Never exceed the maximum rated speed of the rotor and labware in use. Refer to the section on [Run Speeds](#), and derate the run speed as appropriate.

Do not use sharp tools on the rotor that could cause scratches in the rotor surface. Corrosion begins in scratches and may open fissures in the rotor with continued use.

Contents

Revision History, iii

Safety Notice, v

Alerts for Warning, Caution, and Note, v

Safety Information for the VTi 65.2 Rotor, v

VTi 65.2

Vertical-Tube Rotor, 1

Specifications, 1

Description, 2

Preparation and Use, 2

Prerun Safety Checks, 3

Rotor Preparation, 3

Operation, 5

Removal and Sample Recovery, 5

Tubes and Accessories, 6

Temperature Limits, 6

OptiSeal Tubes, 7

Quick Seal Tubes, 7

Run Times, 8

Slow Acceleration/Deceleration, 9

Run Speeds, 9

Selecting CsCl Gradients, 11

Typical Examples for Determining CsCl Run Parameters, 15

Care and Maintenance, 16

Maintenance, 16

Cleaning, 17

Decontamination, 18

Sterilization and Disinfection, 18

Storage, 18

Returning a Rotor, 19

Supply List, 19

Replacement Rotor Parts, 20

Other, 20

Illustrations

- 1 Arranging Tubes in the Rotor, 4
- 2 Precipitation Curves for the VTi 65.2 Rotor, 12
- 3 CsCl Gradients at Equilibrium for the VTi 65.2 Rotor, 13
- 4 CsCl Gradients for Lower Densities, 14

Tables

- 1 Available Tubes for the VTi 65.2 Rotor, 6
- 2 Relative Centrifugal Fields for the VTi 65.2 Rotor, 9

VTi 65.2 Vertical-Tube Rotor

Specifications

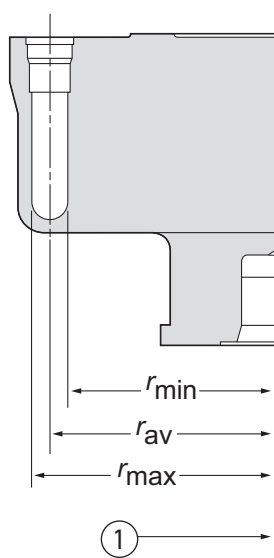

1. Axis of Rotation
 U.S. Pat. No. 4,102,490;
 4,290,550; 4,235,367
 Japanese Pat. No.
 1,469,154

Maximum speed	65,000 RPM
Density rating at maximum speed	1.7 g/mL
Relative Centrifugal Field ^a at maximum speed	
At r_{max} (87.9 mm).....	416,000 × g
At r_{av} (81.3 mm)	385,000 × g
At r_{min} (74.7 mm)	353,000 × g
k factor at maximum speed	10
Conditions requiring speed reductions	see Run Speeds
Number of tube cavities	16
Available tubes	see Table 1
Nominal tube dimensions (largest tube)	13 × 51 mm
Nominal tube capacity	5.1 mL
Nominal rotor capacity	81.6 mL
Approximate acceleration time to maximum speed	
(fully loaded)	11 min
Approximate deceleration time from maximum speed	
(fully loaded)	8 min
Weight of fully loaded rotor	8.5 kg (19 lb)
Rotor material	titanium

a. Relative Centrifugal Field (RCF) is the ratio of the centrifugal acceleration at a specified radius and speed ($r\omega^2$) to the standard acceleration of gravity (g) according to the following formula: $RCF = r\omega^2/g$ — where r is the radius in millimeters, ω is the angular velocity in radians per second (2π RPM /60), and g is the standard acceleration of gravity (9807 mm/s²).
 After substitution: $RCF = 1.12r$ (RPM/1000)²

Description

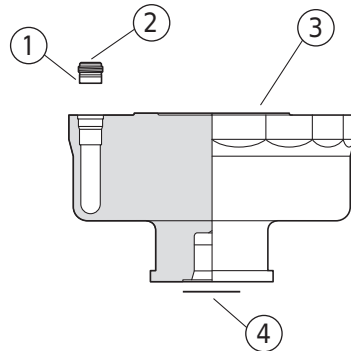

1. Plug Gasket (342882)
2. Plug (368545)
3. Rotor Body
4. Overspeed Disk (330338)

This Beckman Coulter rotor has been manufactured in an ISO 9001 or 13485 facility for use with the specified Beckman Coulter ultracentrifuges.

The VTi 65.2, is designed to centrifuge up to 16 tubes in an upright position. Used in Beckman Coulter class H, R, and S preparative ultracentrifuges, the rotor develops centrifugal forces that can efficiently band DNA or isolate proteins on density gradients. Up to 81.6 mL of gradient and sample can be centrifuged per run.

The rotor is made of titanium and is finished with black polyurethane paint. A tube spacer and rotor plug hold each tube in the rotor, and a plug gasket forms a closure around each plug. Rotor plugs are black-anodized aluminum, and spacers are clear-anodized aluminum for Quick-Seal tubes and gold-anodized aluminum for OptiSeal tubes. Because of the weight of the rotor, drive pins are not required in the rotor drive hub cavity.

For overspeed protection, a photoelectric detector in the ultracentrifuge monitors the overspeed disk on the rotor bottom and shuts down the run if speeds exceeding 65,000 RPM are detected.

See the Warranty at the back of this manual for warranty information.

Preparation and Use

*Specific information about the VTi 65.2 rotor is given here. Information common to this and other rotors is contained in *Rotors and Tubes for Preparative Ultracentrifuges* (publication LR-IM), which should be used together with this manual for complete rotor and accessory operation.*

NOTE Although rotor components and accessories made by other manufacturers may fit in the VTi 65.2 rotor, their safety in this rotor cannot be ascertained by Beckman Coulter. Use of other manufacturers' components or accessories in the VTi 65.2 rotor may void the rotor warranty and should be prohibited by your laboratory safety officer. Only the components and accessories listed in this publication should be used in this rotor.

Prerun Safety Checks



Read the [Safety Notice](#) section at the front of this manual before using the rotor.

- 1 Inspect the rotor plugs and gaskets for damage—the high forces generated in this rotor can cause damaged components to fail.
- 2 Make sure that the rotor is equipped with the correct overspeed disk (330338).
 - a. If the disk is missing or damaged, replace it according to the instructions in *Rotors and Tubes*.

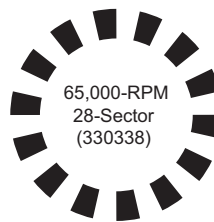

- 3 Verify that only the tubes and accessories listed in [Table 1](#) are being used.
- 4 Check the chemical compatibilities of all materials used.
 - Refer to *Chemical Resistances* (publication IN-175).

Rotor Preparation

For runs at other than room temperature, refrigerate or warm the rotor beforehand for fast equilibration.

- 1 Be sure that the plug threads are clean and lightly but evenly lubricated with Spinkote lubricant (306812) to ensure a proper seal by minimizing thread friction.
- 2 Set the rotor in the rotor vise (342705), which should be bolted or clamped to a rigid surface.

- 3 Load the filled and plugged or sealed tubes symmetrically into the rotor (see page 6 for tube information).
 - If fewer than 16 tubes are being run, they must be arranged symmetrically in the rotor (see [Figure 1](#)).
 - *Opposing tubes must be filled to the same level with liquid of the same density.*

Figure 1 Arranging Tubes in the Rotor

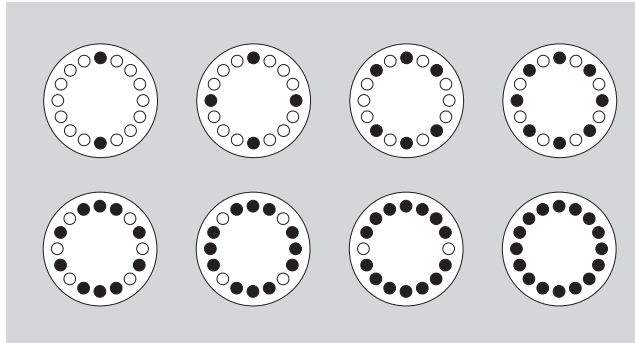

- 4 Complete loading by placing the correct spacers (and floating spacers, if applicable) over the tubes.
 - It is important that each cavity being used is completely filled

- 5 Insert a rotor plug (368545), gasket-end down, over each spacer and screw it in.

NOTE Do not use rotor plugs in empty cavities.

- 6 Using the T40 Torx adapter (976959) and torque wrench (369791), tighten each rotor plug to 13.6 N•m (120 in.-lb).
 - a. *To avoid stripping the plugs, apply downward pressure to the hex plug adapter while tightening the plugs.*
 - Do not overtighten plugs; the top surface of each rotor plug will be slightly below the surrounding rotor surface.

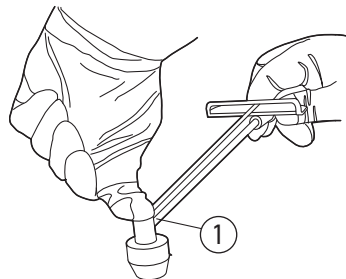

1. Press Down

Operation

- 1 Carefully place the rotor on the drive hub.
- 2 Refer to the instrument instruction manual for ultracentrifuge operation.
- 3 For additional operating information, see the following:
 - [Run Times](#), page 8, for using k factors to adjust run durations.
 - [Run Speeds](#), page 9, for information about speed limitations.
 - [Slow Acceleration/Deceleration](#), page 9, for information about using slow acceleration and deceleration for gradient stability.
 - [Selecting CsCl Gradients](#), page 11, for methods to avoid CsCl precipitation during centrifugation.

Removal and Sample Recovery

 **CAUTION**

If disassembly reveals evidence of leakage, you should assume that some fluid escaped the rotor. Apply appropriate decontamination procedures to the centrifuge and accessories.

- 1 Remove the rotor from the centrifuge by lifting it straight up and off the drive hub.
- 2 Return the rotor to the rotor vise.
 - a. Remove the plugs with the torque wrench and T40 Torx plug adapter.
 - To avoid stripping the plugs, apply downward pressure to the plug adapter while loosening the plugs.
- 3 Use the appropriate removal tool (see the [Supply List](#)) to remove the spacers and tubes.

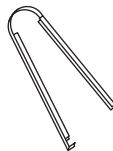

QuickSeal Tube Removal Tool (361668)

Tubes and Accessories

The VTi 65.2 rotor uses only OptiSeal and Quick-Seal tubes; use only the tubes and accessories listed in Table 1. Refer to Rotors and Tubes for information on the chemical resistances of tube and accessory materials. OptiSeal and Quick-Seal tubes are disposable and should be discarded after a single use.

Table 1 Available Tubes for the VTi 65.2 Rotor^a

Tube			Required Accessory		Tube Rack	Max Speed/ RCF/ k factor
Dimensions/ Nominal Volume/	Description	Part Number	Description	Part Number		
13 × 51 mm 5.1 mL	Quick-Seal Ultra-Clear	344075 (pkg/50)	aluminum spacer	342883	342883	65,000 RPM 416,000 × g 10
13 × 51 mm 5.1 mL	Quick-Seal polypropylene	342412 (pkg/50)	aluminum spacer	342883	342883	65,000 RPM 416,000 × g 10
13 × 51 mm 4.9 mL	OptiSeal polypropylene	362185 ^b (pkg/56)	gold-anodized aluminum spacer	362198	362198	65,000 RPM 416,000 × g 10
13 × 25 mm 2 mL	Quick-Seal polypropylene	345829 (pkg/50)	aluminum spacer	342883	342883	65,000 RPM 416,000 × g 10
			floating spacer ^c	345827	345827	

- a. Use only the items listed here..
- b. Includes disposable plastic plugs.
- c. Floating spacers, part of the g-Max system of tube support, are made of Noryl, a registered trademark of General Electric.

Temperature Limits

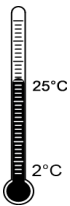

- Plastic tubes have been centrifuge tested for use at temperatures between 2 and 25°C. For centrifugation at other temperatures, pretest tubes under anticipated run conditions.
- If plastic containers are frozen before use, make sure that they are thawed to at least 2°C prior to centrifugation.

OptiSeal Tubes

OptiSeal tubes come with plastic plugs and can be quickly and easily prepared for use without tools or heat. With the tube spacer and rotor plug in place, the combination of g force and hydrostatic pressure during centrifugation ensures a tight, reliable seal that protects your samples. Fill each tube to the base of the stem, leaving no fluid in the stem. Overfilling the tube can cause spillage when the plug is inserted or compromise seal integrity; however, too much air can cause the tube to deform, disrupting gradients and sample bands. Refer to publication IN-189 (*Using OptiSeal Tubes*), included in each package of OptiSeal tubes, for detailed information on the use and care of OptiSeal tubes.



1. Gold Aluminum Spacer
2. Plug

Quick Seal Tubes

Quick-Seal tubes must be sealed prior to centrifugation. These tubes are heat sealed and do not need caps; however, spacers are required on top of the tubes when they are loaded into the rotor.

- 1 Fill Quick-Seal tubes leaving a *small* bubble of air at the base of the neck.
 - a. Do not leave a large air space—too much air can cause excessive tube deformation and make the tube difficult to remove.
-
- 2 Some of the Quick-Seal tubes listed in [Table 1](#) are part of the g -Max system, which uses a combination of small bell-top Quick-Seal tubes and floating spacers (also called g -Max spacers).
 - This means that you can run the shorter tubes in this rotor without reduction in g force.
 - For detailed information on the g -Max system see publication DS-709.

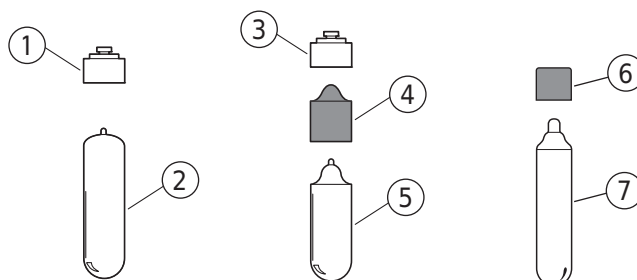

1. Aluminum Spacer
2. Dome-shaped Tube
3. Metal Spacer
4. Floating Spacer
5. Bell-top Tube
6. g -Max Spacer
7. Bell-top Tube

- 3** Refer to *Rotors and Tubes* for detailed information on the use and care of Quick-Seal tubes.
- Quick-Seal tubes are disposable and should be discarded after a single use.

Run Times

The k factor of the rotor is a measure of the rotor's pelleting efficiency. (Beckman Coulter has calculated the k factors for all of its preparative rotors at maximum rated speed and using full tubes.) The k factor is calculated from the formula

EQ 1

$$k = \frac{\ln(r_{\max}/r_{\min})}{\omega^2} \times \frac{10^{13}}{3600}$$

where ω is the angular velocity of the rotor in radians per second ($\omega = 0.105 \times \text{RPM}$), r_{\max} is the maximum radius, and r_{\min} is the minimum radius.

After substitution:

EQ 2

$$k = \frac{(2.533 \times 10^{11}) \ln(r_{\max}/r_{\min})}{\text{RPM}^2}$$

Use the k factor in the following equation to estimate the run time t (in hours) required to pellet particles of known sedimentation coefficient s (in Svedberg units, S).

EQ 3

$$t = \frac{k}{s}$$

Run times can be estimated for centrifugation at less than maximum speed by adjusting the k factor as follows:

EQ 4

$$k_{\text{adj}} = k \left(\frac{65,000}{\text{actual run speed}} \right)^2$$

Run times can also be estimated from data established in prior experiments if the *k* factor of the previous rotor is known. For any two rotors, a and b:

EQ 5

$$\frac{t_a}{t_b} = \frac{k_a}{k_b}$$

Slow Acceleration/Deceleration

Vertical banding of sample and gradient formation occurs with centrifugation. With deceleration, tube contents reorient back to horizontal position. For gradient stability when *performed gradients are used*, select a slow acceleration profile. For the stability of all gradients during deceleration, select a slow deceleration profile. Refer to the appropriate centrifuge user manual for instructions on selecting acceleration and deceleration rates.

Run Speeds

The centrifugal force at a given radius in a rotor is a function of speed. Comparisons of forces between different rotors are made by comparing the rotors' relative centrifugal fields (RCF). When rotational speed is adjusted so that identical samples are subjected to the same RCF in two different rotors, the samples are subjected to the same force. The RCF at a number of rotor speeds is provided in [Table 2](#).

Table 2 Relative Centrifugal Fields for the VTi 65.2 Rotor^a

Rotor Speed (RPM)	Relative Centrifugal Field (× <i>g</i>)			<i>k</i> Factor ^b
	At <i>r</i> _{max} (87.9 mm)	At <i>r</i> _{av} (81.3 mm)	At <i>r</i> _{min} (74.7 mm)	
65,000	416,000	385,000	354,000	10
60,000	354,000	328,000	301,000	11
55,000	298,000	275,000	253,000	14
50,000	246,000	228,000	209,000	16
45,000	199,000	184,000	169,000	20
40,000	158,000	146,000	134,000	26
35,000	121,000	112,000	103,000	34
30,000	88,600	82,000	75,300	46
25,000	61,500	56,900	52,300	66
20,000	39,400	36,400	33,500	103
15,000	22,200	20,500	18,800	183
10,000	9,850	9,110	8,370	412

- Entries in this table are calculated from the formula $RCF = 1.12r (RPM/1000)^2$ and then rounded to three significant digits.
- Calculated for all Beckman Coulter preparative rotors as a measure of the rotor's relative efficiency in pelleting sample in water at 20°C.

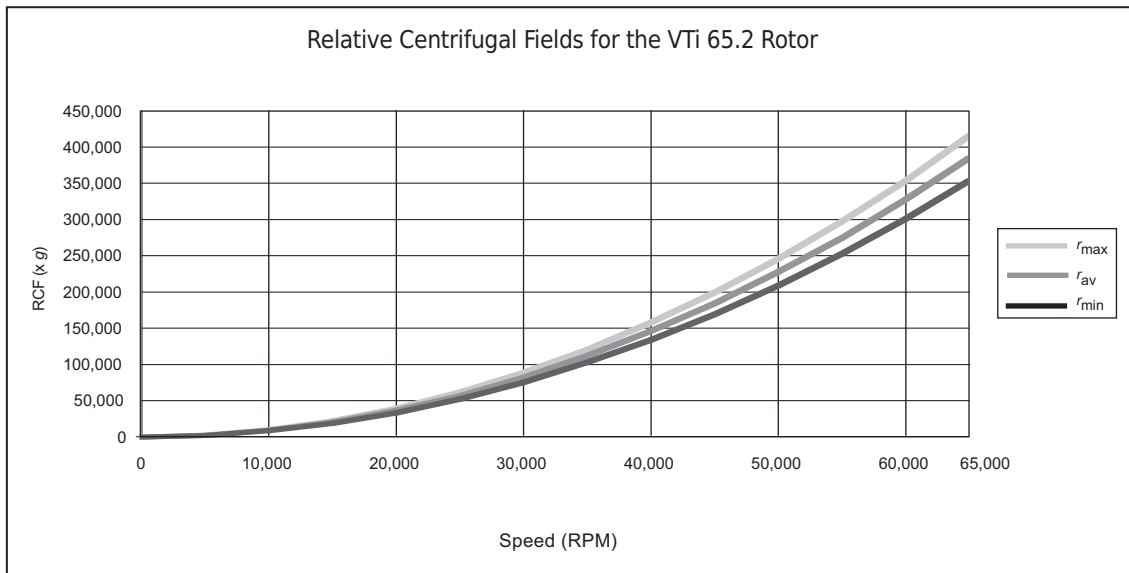

Speeds must be reduced under the following circumstances:

1. If nonprecipitating solutions more dense than 1.2 g/mL are centrifuged, the maximum allowable run speed must be reduced according to the following equation:

EQ 6

$$\text{reduced maximum speed} = (65,000 \text{ rpm}) \sqrt{\frac{1.2 \text{ g/mL}}{\rho}}$$

where ρ is the density of the tube contents. This speed reduction will protect the rotor from excessive stresses due to the added tube load. *Note, however, that the use of this formula may still produce maximum speed values that are higher than the limitations imposed by the use of certain tubes or adapters.* In such cases, use the lower of the two values.

2. *Further speed limits must be imposed when CsCl or other self-forming-gradient salts are centrifuged, as equation (6) does not predict concentration limits/speeds that are required to avoid precipitation of salt crystals. Precipitation during centrifugation would alter the density distribution of CsCl and this would change the position of the sample bands. Figure 2, Figure 3, and Figure 4, together with the description and examples below, show how to reduce run speeds when using CsCl gradients.*

Selecting CsCl Gradients

NOTE The curves in [Figure 2](#), [Figure 3](#), and [Figure 4](#) are for solutions of CsCl salt dissolved in distilled water only. If other salts are present in significant concentrations, the overall CsCl concentration may need to be reduced.

Solid CsCl has a density of 4 g/mL, and if precipitation during centrifugation may cause rotor failure. Precipitation will also alter density distribution, and therefore sample separation. In general, lower speeds provide better resolution, but longer run times will be required to achieve particle separation and gradient equilibrium. Curves are provided up to the maximum rated speed of the rotor.

Rotor speed is used to control the slope of a CsCl density gradient, and must be limited so that CsCl precipitation is avoided. [Figure 2](#) gives the CsCl concentration-limiting curves for full tubes. The reference curves in [Figure 3](#) show equilibrium gradients that result from centrifugation using the maximum densities allowed by [Figure 2](#). Each curve in [Figure 3](#) is within the density limits allowed for the VTi 65.2 rotor: each curve was generated for a single run speed using the maximum allowable homogeneous CsCl densities that avoid precipitation at that speed. [Figure 4](#) gives the gradients that result from centrifugation using lower-than-maximum-allowable CsCl concentrations. These reduced-density curves can be used to make particles band more towards the middle of a tube, where volume between bands will be greatest. (The gradients in [Figure 3](#) and [Figure 4](#) can be generated from step or linear gradients, or from homogeneous solutions. But the total amount of CsCl in solution must be equivalent to a homogeneous solution corresponding to the concentrations specified.)

Figure 2 Precipitation Curves for the VTi 65.2 Rotor*

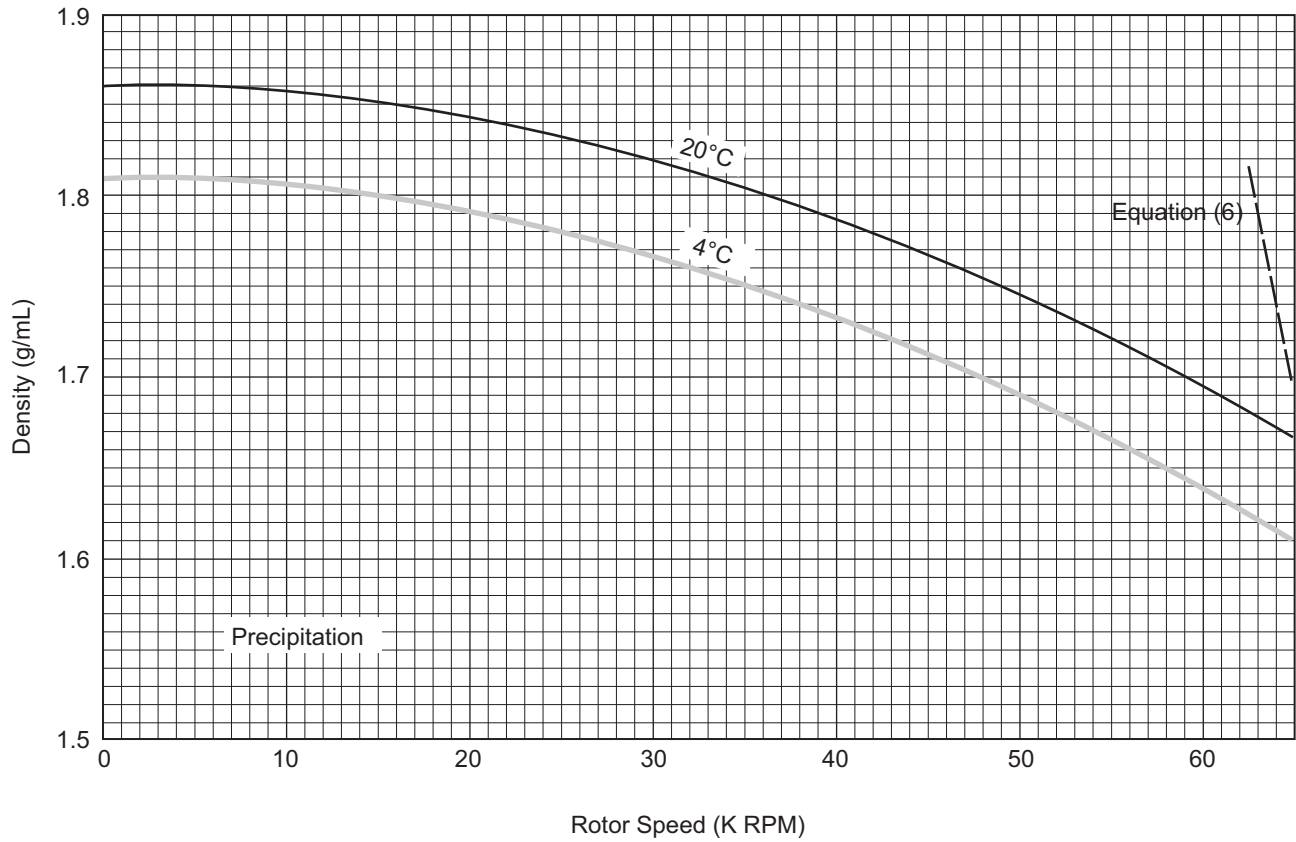

* Using combinations of rotor speeds and homogeneous CsCl solution densities that intersect on or below these curves ensures that CsCl will not precipitate during centrifugation. If gradient and sample solution do not completely fill the tube, add mineral oil to fill. (Do not use an oil overlay in Ultra-Clear tubes.) The dashed line is a representation of equation(6), and is shown here to illustrate the inability of that equation to predict CsCl precipitation.

Figure 3 CsCl Gradients at Equilibrium for the VTi 65.2 Rotor*
Volume (mL)

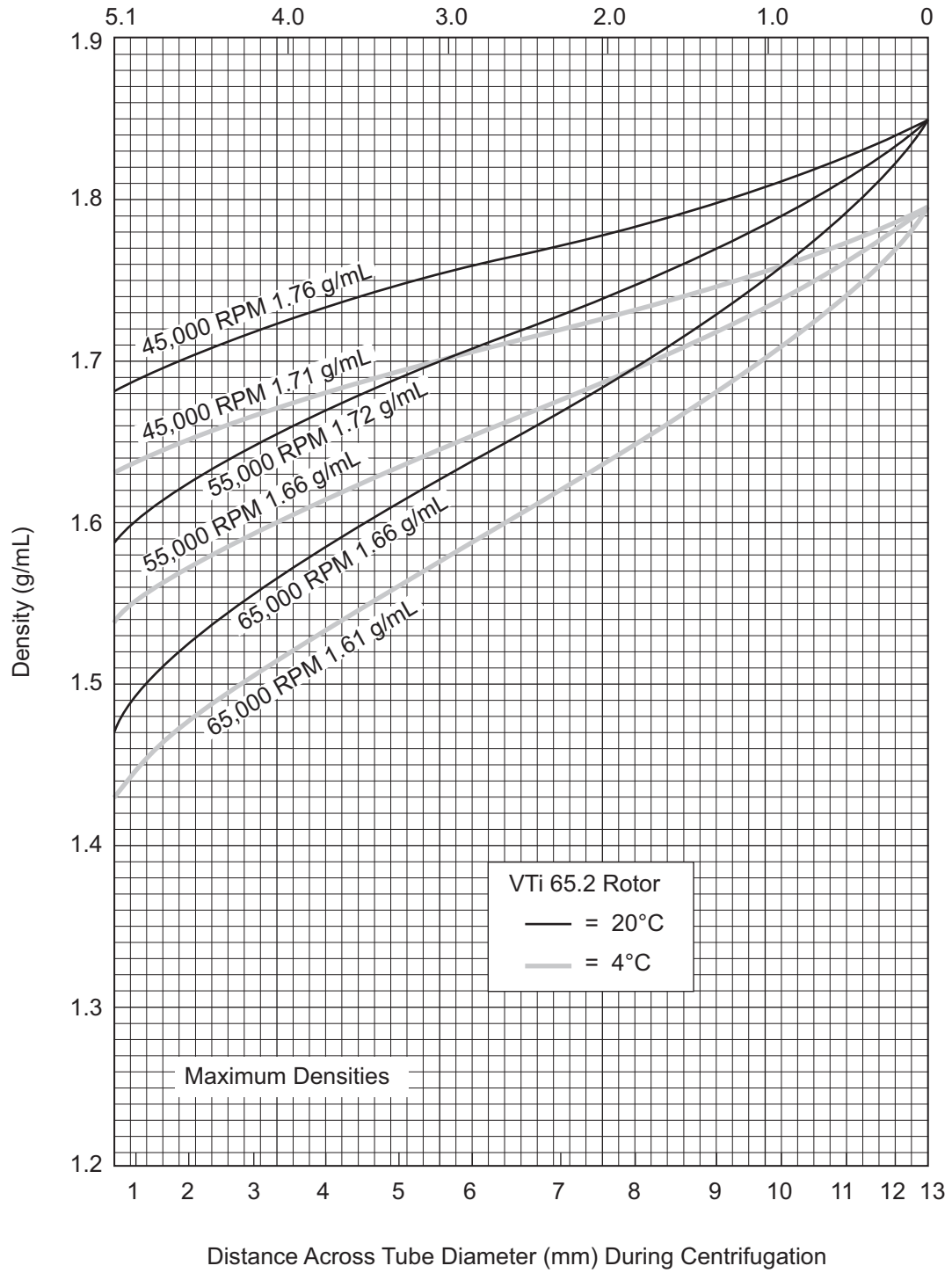

* Centrifugation of homogeneous CsCl solutions at the maximum allowable speeds (from Figure 2) results in gradients presented here. The homogeneous CsCl solution density used to generate each curve is printed along the curve.

Figure 4 CsCl Gradients for Lower Densities*

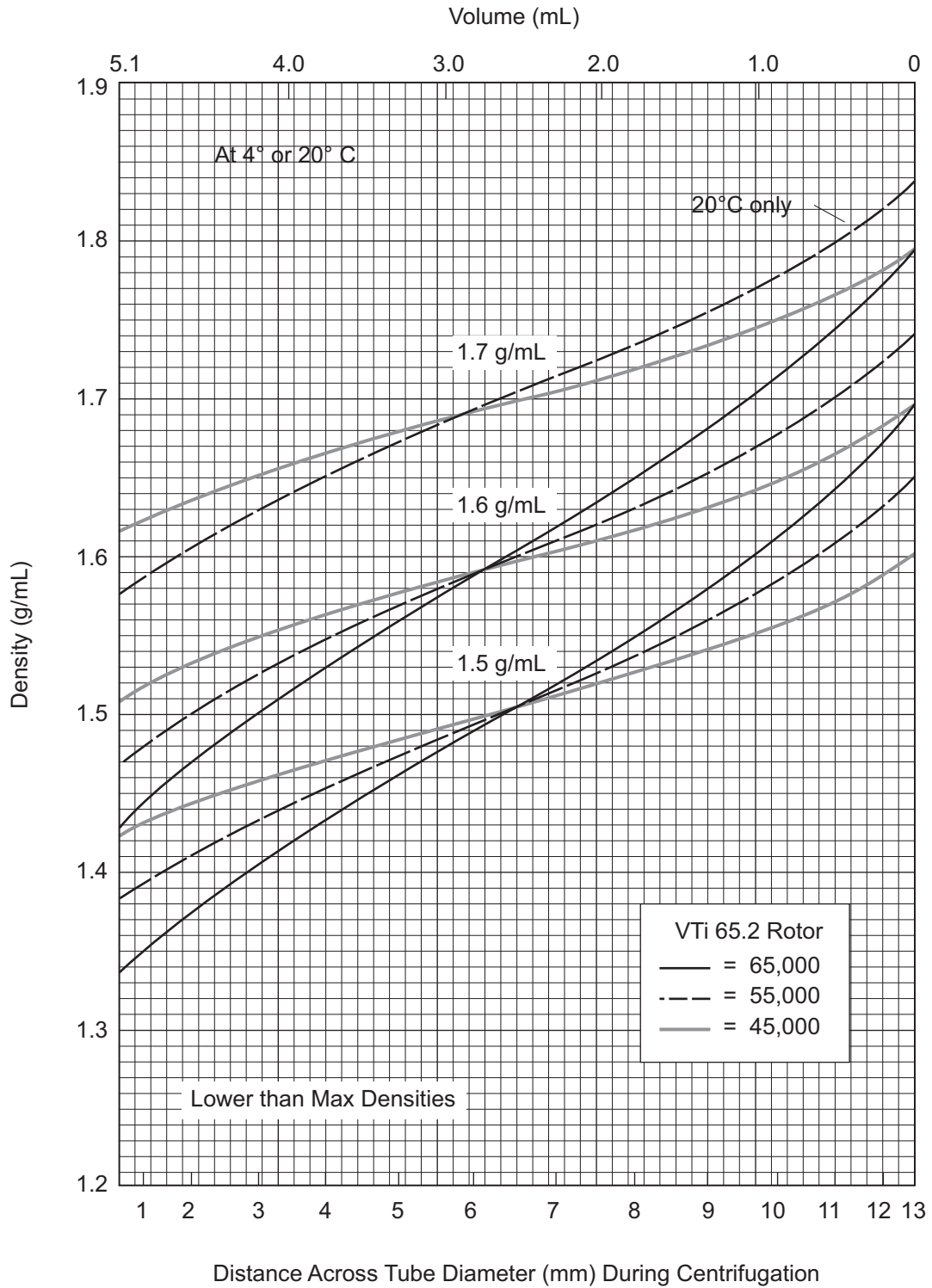

* Centrifugation of less-than-maximum-allowable-density solutions may sometimes give better particle separations. Densities used to generate curves are printed along the curves.

Typical Examples for Determining CsCl Run Parameters

Example A:

Knowing homogeneous CsCl solution density (1.69 g/mL) and approximate particle buoyant densities (1.70 and 1.65 g/mL), at 20°C, where will particles band?

- 1 In [Figure 2](#), find the curve that corresponds to the required run temperature (20°C).
 - The maximum allowable rotor speed is determined from the point where this curve intersects the homogeneous CsCl density (59,000 RPM).
- 2 In [Figure 3](#), sketch in a horizontal line corresponding to each particle's buoyant density.
- 3 Mark the point in the figure where each particle density intersects the curve corresponding to the selected run speed and temperature.
 - Particles will band at these locations across the tube diameter (lower axis of [Figure 3](#)) at equilibrium during centrifugation.
 - After centrifugation, the bands will reorient (top axis).

If the required gradient curve is not presented in [Figure 3](#), interpolate between the nearest curves and draw it in. Using the horizontal axis, it can be estimated that these particles will be about 2 mm apart at equilibrium during centrifugation. After reorientation, they will be separated by 1 mL (top axis).

Example B:

Knowing particle buoyant densities (1.60 and 1.61 g/mL), how do you achieve the best separation?

- 1 In [Figure 4](#), sketch in a horizontal line corresponding to each particle's buoyant density.
- 2 Select the curve at the temperature (20°C) that gives the best particle separation.
 - Particles will band at points across the tube diameter where the sketched lines intersect this curve (lower axis) at equilibrium during centrifugation.
 - After centrifugation the bands will reorient (top axis).
- 3 Note the run speed along the selected curve.
- 4 Select the maximum homogeneous CsCl density that corresponds to the temperature and run speed established above.
 - These parameters will provide the particle-banding pattern selected in Step 2.

In this case the 1.60 g/mL 45,000-RPM curves in [Figure 4](#) give the best separation. These curves intersect the particle buoyant densities in such a way that particles band about 0.75 mm apart at equilibrium during centrifugation (lower axis). Bands are located in the middle of the tube.

Care and Maintenance

Maintenance

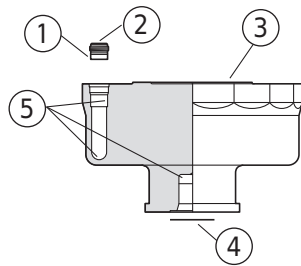

1. Plug Gasket (342882)
2. Plug (368545)
3. Rotor Body
4. Overspeed Disk (330338)
5. Check for Corrosion

NOTE Do not use sharp tools on the rotor that could cause scratches in the rotor surface. Corrosion begins in scratches and may open fissures in the rotor with continued use.

-
- 1 Regularly inspect the overspeed disk.
 - a. If it is scratched, damaged, or missing, replace it.
 - Replacement instructions are in *Rotors and Tubes*.

 - 2 Regularly inspect the rotor plugs (368545) for wear (worn threads will have a shiny appearance).
 - a. Replace rotor plugs (as a set) if they show signs of wear.

 - 3 Regularly lubricate the metal threads in the rotor plugs with a thin, even coat of Spinkote lubricant.
 - Failure to keep these threads lubricated can result in damaged threads.

 - 4 The rotor plug gaskets (340825) require no maintenance except cleaning.
 - a. Replace damaged gaskets.
 - b. To replace the plug gasket, use the sharpened end of a cotton swab or similar nonmetallic tool to pry the gasket from the plug.
 - Do this carefully so that the plug is not damaged.
 - The new gasket snaps onto the grooved end of the plug.

- 5 Refer to Appendix A in *Rotors and Tubes* for the chemical resistances of rotor and accessory materials.
 - Your Beckman Coulter representative provides contact with the Field Rotor Inspection Program and the rotor repair center.

Cleaning

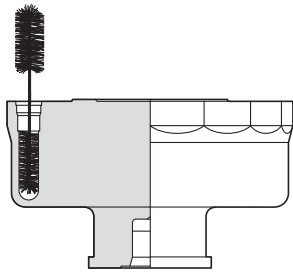

Wash the rotor and rotor components immediately if salts or other corrosive materials are used or if spillage has occurred. Do not allow corrosive materials to dry on the rotor.

Under normal use, wash the rotor frequently (at least weekly) to prevent buildup of residues.

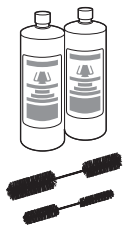

- 1 Wash the rotor, plugs, and spacers in a mild detergent, such as Beckman Solution 555 (339555), that won't damage the rotor.
 - a. Dilute the detergent 10 to 1 with water.

NOTE Do not wash rotor components in a dishwasher. Do not soak in detergent solution for long periods, such as overnight.

 - The Rotor Cleaning Kit contains two plastic-coated brushes and two quarts of Solution 555 for use with rotors and accessories.

- 2 Rinse the cleaned rotor and components with distilled water.

- 3 Air-dry the rotor and lid upside down.
 - a. *Do not use acetone to dry the rotor.*

- 4 Clean plug threads as necessary.
 - a. Use a brush and concentrated Solution 555.
 - b. Rinse and dry thoroughly, then lubricate lightly but evenly with Spinkote to coat all threads.

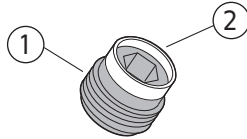

1. Threads
2. Gasket

Decontamination



If the rotor or other components are contaminated with toxic or pathogenic materials, follow appropriate decontamination procedures as outlined by your laboratory safety officer. Check Appendix A in *Rotors and Tubes* to be sure the decontamination method will not damage any part of the rotor.

Sterilization and Disinfection

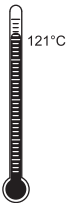

- The rotor and all rotor components, except those made of Noryl, can be autoclaved at 121°C for up to an hour. Remove the plugs from the rotor and place the rotor, plugs, and spacers in the autoclave upside down.
- Ethanol (70%)* or hydrogen peroxide (6%) may be used on all rotor components, including those made of plastic. Bleach (sodium hypochlorite) may be used, but may cause discoloration of anodized surfaces. Use the minimum immersion time for each solution, per laboratory standards.

While Beckman Coulter has tested these methods and found that they do not damage the rotor or components, no guarantee of sterility or disinfection is expressed or implied. When sterilization or disinfection is a concern, consult your laboratory safety officer regarding proper methods to use.

Quick-Seal tubes are disposable and should be discarded after a single use.

Storage

When it is not in use, store the rotor in a dry environment (not in the instrument) with plugs removed to allow air circulation so moisture will not collect in the tube cavities.

* Flammability hazard. Do not use in or near operating ultracentrifuges.

Returning a Rotor

Before returning a rotor or accessory for any reason, prior permission must be obtained from Beckman Coulter, Inc. This form may be obtained from your local Beckman Coulter sales office. The form, entitled *Returned Material Authorization* (RMA) for United States returns or *Returned Goods Authorization* (RGA) for international returns, should contain the following information:

- rotor type and serial number,
- history of use (approximate frequency of use),
- reason for the return,
- original purchase order number, billing number, and shipping number, if possible,
- name and email address of the person to be notified upon receipt of the rotor or accessory at the factory,
- name and email address of the person to be notified about repair costs, etc.

To protect our personnel, it is the customer's responsibility to ensure that all parts are free from pathogens and/or radioactivity. Sterilization and decontamination must be done before returning the parts. Smaller items (such as tubes, bottles, etc.) should be enclosed in a sealed plastic bag.

*All parts must be accompanied by a note, plainly visible on the outside of the box or bag, stating that they are safe to handle and that they are not contaminated with pathogens or radioactivity. **Failure to attach this notification will result in return or disposal of the items without review of the reported problem.***

Use the address label printed on the RMA/RGA form when mailing the rotor and/or accessories.

Customers located outside the United States should contact their local Beckman Coulter office.

Supply List

NOTE Publications referenced in this manual can be obtained at www.beckman.com, by calling Beckman Coulter at 1-800-742-2345 in the United States, or by contacting your local Beckman Coulter office.

See the Beckman Coulter *Ultracentrifuge Rotors, Tubes & Accessories* catalog (BR-8101, available at www.beckman.com) or contact Beckman Coulter Sales (1-800-742-2345 in the United States) for detailed information on ordering parts and supplies. For your convenience, a partial list is given below.

Replacement Rotor Parts

Description	Part Number
VTi 65.2 rotor assembly	346431
Rotor plug	368545
Rotor plug gasket	342882
Overspeed disk (65,000 RPM)	330338
Rotor vise assembly	342705

Other

NOTE For MSDS information, go to the Beckman Coulter website at www.beckman.com.

Description	Part Number
Tubes and accessories	see Table 1
OptiSeal tube rack assembly	360534
Quick-Seal Cordless Tube Topper kit, 60 Hz	358312
Quick-Seal Cordless Tube Topper kit, 50 Hz (Europe)	358313
Quick-Seal Cordless Tube Topper kit, 50 Hz (Great Britain)	358314
Quick-Seal Cordless Tube Topper kit, 50 Hz (Australia)	358315
Quick-Seal Cordless Tube Topper kit, 50 Hz (Canada)	367803
Tube Topper rack (13-mm dia. tubes)	348122
Torque wrench	858121
T40 Torx plug adapter	976959
Tube removal tool	361668
Floating spacer removal tool	338765
Spinkote lubricant (2 oz)	306812
Silicone vacuum grease (1 oz)	335148
Rotor Cleaning Kit	339558
Beckman Solution 555 (1 qt)	339555
Rotor cleaning brush	339379

Beckman Coulter, Inc.

Ultracentrifuge Rotor Warranty

All Beckman Coulter ultracentrifuge Fixed Angle, Vertical Tube, Near Vertical Tube, Swinging Bucket, and Airfuge rotors are warranted against defects in materials or workmanship for the time periods indicated below, subject to the Warranty Conditions stated below.

Preparative Ultracentrifuge Rotors	5 years — No Proration
Analytical Ultracentrifuge Rotors	5 years — No Proration
ML and TL Series Ultracentrifuge Rotors	5 years — No Proration
Airfuge Ultracentrifuge Rotors	1 year — No Proration
For Zonal, Continuous Flow, Component Test, and Rock Core Ultracentrifuge Rotors, see separate warranty.	

Warranty Conditions (as applicable)

1. This warranty is valid for the time periods indicated above from the date of shipment to the original Buyer by Beckman Coulter or an authorized Beckman Coulter representative.
2. This warranty extends only to the original Buyer and may not be assigned or extended to a third person without written consent of Beckman Coulter.
3. This warranty covers the Beckman Coulter Centrifuge Systems only (including but not limited to the centrifuge, rotor, and accessories) and Beckman Coulter shall not be liable for damage to or loss of the user's sample, non-Beckman Coulter tubes, adapters, or other rotor contents.
4. This warranty is void if the Beckman Coulter Centrifuge System is determined by Beckman Coulter to have been operated or maintained in a manner contrary to the instructions in the operator's manual(s) for the Beckman Coulter Centrifuge System components in use. This includes but is not limited to operator misuse, abuse, or negligence regarding indicated maintenance procedures, centrifuge and rotor classification requirements, proper speed reduction for the high density of certain fluids, tubes, and tube caps, speed reduction for precipitating gradient materials, and speed reduction for high-temperature operation.
5. Rotor bucket sets purchased concurrently with or subsequent to the purchase of a Swinging Bucket Rotor are warranted only for a term co-extensive with that of the rotor for which the bucket sets are purchased.
6. This warranty does not cover the failure of a Beckman Coulter rotor in a centrifuge not of Beckman Coulter manufacture, or if the rotor is used in a Beckman Coulter centrifuge that has been modified without the written permission of Beckman Coulter, or is used with carriers, buckets, belts, or other devices not of Beckman Coulter manufacture.
7. Rotor parts subject to wear, including but not limited to rotor O-rings, VTi, NVT, TLV, MLN, and TLN rotor tube cavity plugs and gaskets, tubing, tools, optical overspeed disks, bearings, seals, and lubrication are excluded from this warranty and should be frequently inspected and replaced if they become worn or damaged.
8. Keeping a rotor log is not mandatory, but may be desirable for maintenance of good laboratory practices.

Repair and Replacement Policies

1. If a Beckman Coulter rotor is determined by Beckman Coulter to be defective, Beckman Coulter will repair or replace it, subject to the Warranty Conditions. A replacement rotor will be warranted for the time remaining on the original rotor's warranty.
2. If a Beckman Coulter centrifuge is damaged due to a failure of a rotor covered by this warranty, Beckman Coulter will supply free of charge (i) all centrifuge parts required for repair (except the drive unit, which will be replaced at the then current price less a credit determined by the total number of revolutions or years completed, provided that such a unit was manufactured or rebuilt by Beckman Coulter), and (ii) if the centrifuge is currently covered by a Beckman Coulter warranty or Full Service Agreement, all labor necessary for repair of the centrifuge.
3. If a Beckman Coulter rotor covered by this warranty is damaged due to a malfunction of a Beckman Coulter ultracentrifuge covered by an Ultracentrifuge System Service Agreement, Beckman Coulter will repair or replace the rotor free of charge.
4. If a Beckman Coulter rotor covered by this warranty is damaged due to a failure of a Beckman Coulter tube, bottle, tube cap, spacer, or adapter, covered under the Conditions of this Warranty, Beckman Coulter will repair or replace the rotor and repair the instrument as per the conditions in policy point (2) above, and the replacement policy.
5. Damage to a Beckman Coulter rotor or instrument due to the failure or malfunction of a non-Beckman Coulter tube, bottle, tube cap, spacer, or adapter is not covered under this warranty, although Beckman Coulter will assist in seeking compensation under the manufacturer's warranty.

Disclaimer

IT IS EXPRESSLY AGREED THAT THE ABOVE WARRANTY SHALL BE IN LIEU OF ALL WARRANTIES OF FITNESS AND OF THE WARRANTY OF MERCHANTABILITY AND BECKMAN COULTER, INC. SHALL HAVE NO LIABILITY FOR SPECIAL OR CONSEQUENTIAL DAMAGES OF ANY KIND WHATSOEVER ARISING OUT OF THE MANUFACTURE, USE, SALE, HANDLING, REPAIR, MAINTENANCE, OR REPLACEMENT OF THE PRODUCT.

Factory Rotor Inspection Service

Beckman Coulter, Inc., will provide free mechanical and metallurgical inspection in Indianapolis, Indiana, USA, of any Beckman Coulter rotor at the request of the user. (Shipping charges to Beckman Coulter are the responsibility of the user.) Rotors will be inspected in the user's laboratory if the centrifuge in which they are used is covered by an appropriate Beckman Coulter Service Agreement. Contact your local Beckman Coulter office for details of service coverage or cost.

Before shipping, contact the nearest Beckman Coulter Sales and Service office and request a Returned Goods Authorization (RGA) form and packaging instructions. Please include the complete rotor assembly, with buckets, lid, handle, tube cavity caps, etc. A SIGNED STATEMENT THAT THE ROTOR AND ACCESSORIES ARE NON-RADIOACTIVE, NON-PATHOGENIC, NON-TOXIC, AND OTHERWISE SAFE TO SHIP AND HANDLE IS REQUIRED.

Related Documents

Rotors and Tubes for Preparative Ultracentrifuges (LR-IM)

- Rotors
- Tubes, Bottles, and Accessories
- Using Tubes, Bottles, and Accessories
- Using Fixed-Angle Rotors
- Using Swinging-Bucket Rotors
- Using Vertical-Tube and Near-Vertical Tube Rotors
- Care and Maintenance
- Chemical Resistances for Beckman Coulter Centrifugation Products
- Use of the w2t Integrator
- The Use of Cesium Chloride Curves
- Gradient Materials
- References
- Glossary

Available in hard copy or electronic pdf by request.

Rotors and Tubes CD (369668)

- Rotors and Tubes for Tabletop Preparative Ultracentrifuges
- Rotors and Tubes for J2, J6, Avanti J Series Centrifuges
- Rotors and Tubes for Preparative Ultracentrifuges
- Rotor Safety Bulletin
- Chemical Resistances for Beckman Coulter Centrifugation Products

Included with shipment of instrument.

Additional References

- Chemical Resistances for Beckman Coulter Centrifugation Products (IN-175)
- Beckman Coulter Ultracentrifuge Rotors, Tubes & Accessories catalog (BR-8101)
- Using OptiSeal Tubes (IN-189)

Available in hard copy or electronic pdf by request.

Data Sheets

- *g*-Max System: Short Pathlengths in High Force Fields (DS-709B)

Available at www.beckman.com/techdocs

www.beckman.com

